

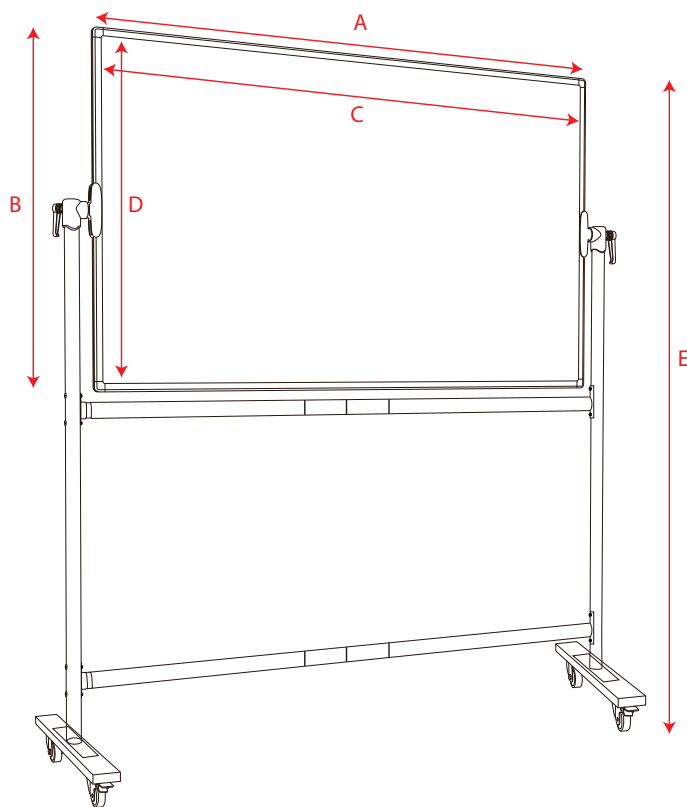







Tablica obrotowo-jezdna TELESCOPIC korkowa

Rotated and mobile board TELESCOPIC

Mobile Tafeln TELESCOPIC

Поворотно-мобильная доска TELESCOPIC



 ID	A (mm)	B (mm)	C (mm)	D (mm)	E (mm)		
TCCOJ129TP	1200	900	1180	880	1750	2	 5 903273 04 1372
TCCOJ1510TP	1500	1000	1480	980	1820	2	 5 903273 04 1389
TCCOJ1812TP	1800	1200	1780	1180	1920	2	 5 903273 04 1396
TCCOJ2010TP	2000	1000	1980	980	1920	2	 5 903273 04 1402